

High Resolution Wide Dynamic Range Dome

Key Features

- 1/3" SONY Super HAD CCD
- 560TVL High Resolution
- Wide Dynamic Range
- DC Iris Vari-Focal Lens (f=2.8~10mm)
- 3-Axis Camera Construction
- 12VDC/24VAC Dual Voltage



Specifications

Model	CV-DC580VWD
Signal System	NTSC
Scanning System	2:1 Interlace
Scanning Frequency(H)	15.734 KHz
Scanning Frequency(V)	59.94 Hz
Image Sensor	1/3" Sony Super HAD CCD
Sync. System	Internal
Total Pixels Number	811(H) x 508(V) 410K
Effective Pixels Number	768(H) x 494(V) 380K
Horizontal Resolution	560 TV Lines
Video Output Level	1.0 Vp-p (75Ω, Composite)
S/N Ratio	More than 50dB (AGC off, BW mode)
Digital Zoom Ratio	16x
Lens	DC Iris Vari-focal Lens (f=2.8~10mm)
Min. Illumination	0.0003 Lux(DSS On, B/W)
Day & Night System	ICR(AGC Type)
White Balance	Auto
AGC	Auto
BLC	On/Off
Flickerless	On/Off
Digital Slow Shutter	Off/ 2x~160x Field
OSD Menu	On/Off
WDR (Wide Dynamic Range)	On/Auto(0~15, Max. 60dB)/Off
Privacy Zone	On/Off (4 Programmable)
Motion detection	4 Zone
Electronic Shutter Speed	1/60~1/100,000 sec
Power Voltage	12VDC/24VAC
Power Consumption	Max. 3.3W / 270mA
Dimensions	100.0(Ø) x 102.0(H)mm
Weight (Net)	Approx. 366g

Dimensions

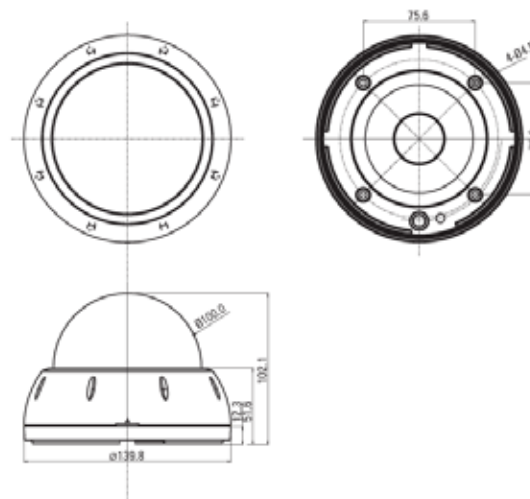

ClearVision, the ClearVision Logo and Light Max are registered trademarks of Clearvision, Inc.
 Sony is a registered trademark of Sony Corporation
 Product specifications and availability are subject to change without notice.
 © Copyright 2008, Clearvision, Inc. All rights reserved.